



## Installation instructions

Akrapovič Exhaust System  
**Slip-On and Optional Headers**  
for the  
**KAWASAKI ZZR 1400**



\*503297\*

**Congratulations on purchasing an Akrapovič exhaust system. Please read the entire installation manual prior to undertaking any activities related to installation of your new Akrapovič exhaust system. In case you do not fully understand the manual or any of its parts, please contact your authorized dealer!**

**This product should be installed by someone with sufficient knowledge of exhaust systems and their installation, and appropriate hand or power tools. If you are not qualified for this work, please utilize a certified mechanic for installation. By installing Your Akrapovič exhaust system, you indicate that you have read the installation manual in its entirety and you agree with the terms stated herein.**

**It is your responsibility to follow all installation instruction guidelines supplied with the Akrapovič exhaust system and undertake all necessary safety precautions. Akrapovič d.d. assumes no responsibility for damages occurring from misuse, abuse, improper installation, improper operation, lack of responsible care, or all previously stated reasons resulting from incompatibility with other manufacturer's products and/or systems.**

## **IMPORTANT INFORMATION**

### **Exclusion of Certain Liability**

1. The manufacturer, importer or dealer shall not be liable for any incidental damage including personal injury or any other damages caused by improper installation or operation of the Akrapovič exhaust system. When installing the Akrapovič exhaust system be careful that the exhaust system does not touch other parts sensitive to high temperature.
2. Akrapovič makes no representation or warranties with regard to damage caused by the improper installation, use and maintenance of the Akrapovič exhaust system. The warranty is limited to defects recognized by our technical department and due to normal use, and excludes items subject to normal wear (gaskets and damping wool). The guarantee is void in case of accident, modification, improper or competition use.
3. Do not attempt to install the Akrapovič exhaust system on a vehicle model for which it was not made or tested by Akrapovič.
4. When the exhaust system gets very hot during operation, be careful not to burn yourself on the exhaust system or parts which are in direct contact with it, even when the engine is not running. Also protect other people, especially children, from the injuries mentioned above.
5. In some cases Akrapovič exhaust system kits contain chemical products (ceramic anti-seizing grease; bolt sealant). Handle with care, do not inhale or swallow. Avoid excessive contact with skin, eyes or mucous membranes. Keep out of reach of children.
6. Technical specifications of Akrapovič exhaust systems and related products are subject to change without notice.
7. Before removing the original exhaust system from your vehicle, please compare the parts you received with the list of materials provided in the installation manual in order to assure that you have all the parts necessary for the installation of your new Akrapovič exhaust system.
8. Although this manual consists of instructions for installation in written form, as well as photographs and pictures representing individual steps of the installation, please note that the photographs and pictures are symbolic and are intended for representation of general overview only. The photographs and pictures contained herein should serve as a guideline only and actual installation of the exhaust system may not correspond with the photographs and pictures entirely.
9. The process of uninstalling the original exhaust system may vary depending on the existing exhaust system. Please follow the original exhaust system manufacturer's instructions for uninstalling the original exhaust system.

### **Trademarks**

The Akrapovič Exhaust System Technology logo is a registered trademark of Akrapovič d.d.

### **Akrapovič website**

Information about Akrapovič exhaust systems and related products is available on the Akrapovič website at: <http://www.akrapovic.com/>

### **Copyright**

No part of the Akrapovič exhaust system or its documentation may be reproduced or distributed in any form or by any means without the prior written authorization of the Akrapovič company.

© Akrapovič, d.d. All rights reserved.

## Symbols

The following symbols are used throughout these installation instructions:



TOOLS REQUIRED



TIGHTENING TORQUE



INSTALLATION TIP



CAUTION OR WARNING



**USE BOLT SEALANT;** Apply 3 to 4 small drops of bolt sealant onto the cleaned and degreased threads before tightening the bolts. **WARNING! Avoid contact with skin, eyes and mucous membranes. Do not inhale fumes. Keep out of reach of children.**



**USE ANTI-SEIZE LEAD-FREE COPPER PASTE** (black tube); Provides trouble-free and long-lasting protection against seizing, corrosion and rusting of bolts, threaded ends, nuts, joints, etc. Also protects against vibration, wear and impact. **WARNING! Avoid eye contact. Avoid excessive skin contact. Keep out of reach of children.**



**USE ANTI-SEIZING GREASE** (white tube); Prevents seizing, corrosion and excessive wear between the titanium components of your exhaust system. **WARNING! Avoid eye contact. Avoid excessive skin contact. Keep out of reach of children.**

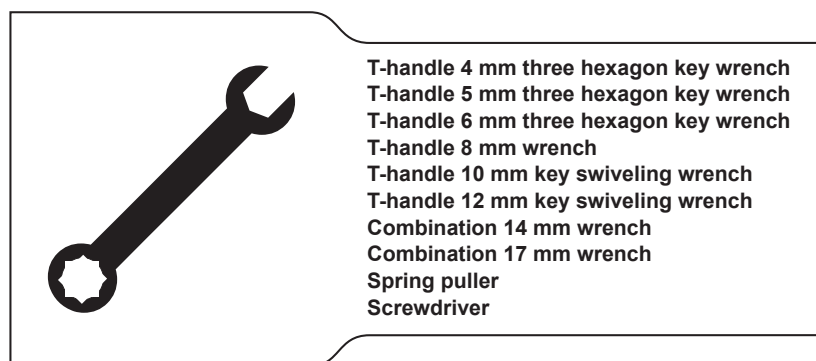

**BEFORE INSTALLING, CHECK SCHEMATIC OF THE EXHAUST SYSTEM! THE LATEST VERSION OF THE PARTS LIST AND SCHEMATIC DRAWINGS OF THE PRODUCTS ARE AVAILABLE ON OUR WEB PAGE.**



**IF ANY ITEMS IN THE AKRAPOVIČ EXHAUST SYSTEM PACKAGE ARE MISSING, PLEASE CONTACT YOUR AUTHORIZED DEALER. KEEP THE SCHEMATIC FOR FUTURE REFERENCE.**



**THESE INSTALLATION INSTRUCTIONS MUST BE READ CAREFULLY IN ORDER TO ENSURE PROPER INSTALLATION AND OPERATION OF THE AKRAPOVIČ EXHAUST SYSTEM.**



**THE EXHAUST SYSTEM CAN BE EXTREMELY HOT. ALLOW THE EXHAUST AND ENGINE TO COOL DOWN BEFORE BEGINNING INSTALLATION.**



**WE ADVISE YOU TO LEAVE INSTALLATION TO A QUALIFIED SERVICEMAN. IMPROPER INSTALLATION MAY RESULT IN A SHORTER LIFETIME OF THE EXHAUST SYSTEM AND/OR DAMAGE TO THE VEHICLE.**

**REMOVAL OF STOCK EXHAUST SYSTEM:**

1. Put the motorcycle on a side stand, we recommend a racing stand. Make sure, that surface is solid and flat.
2. Loosen the marked clamps at the left and right link pipes - collector joint (**Figure 1**).



Figure 1

3. Unscrew the marked link pipe bracket bolt on the right side of the motorcycle (**Figure 2**).

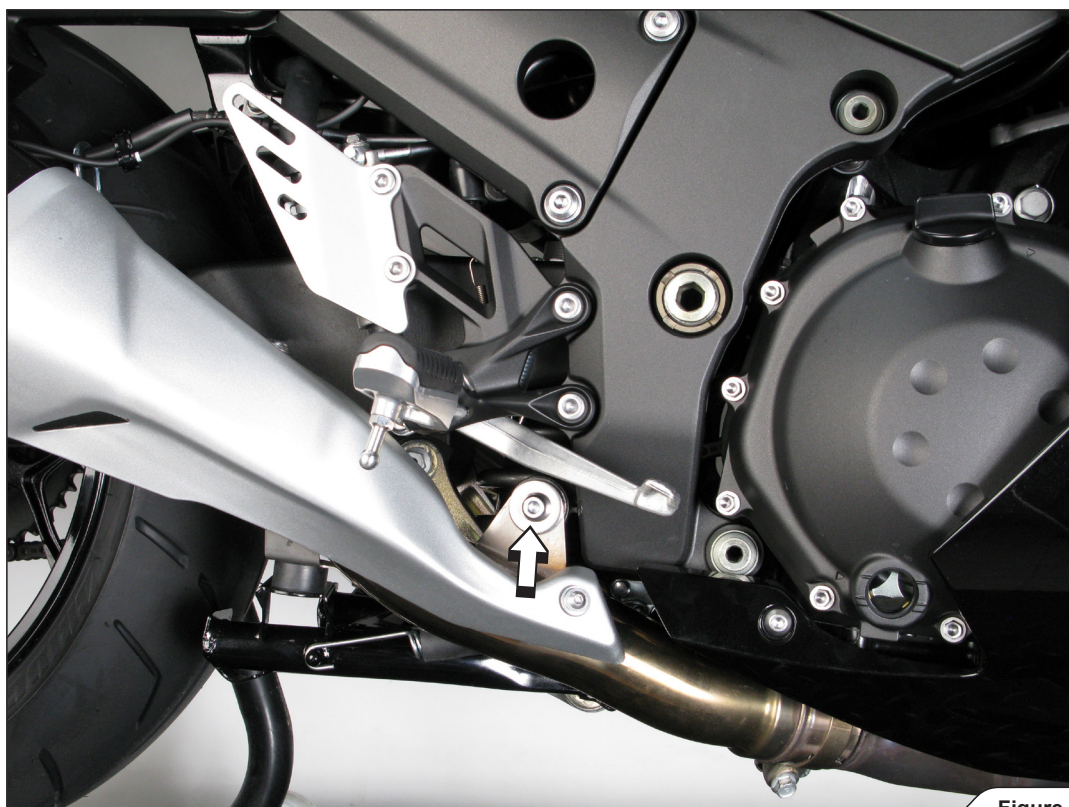

Figure 2



4. Unscrew the marked bolts and remove the stock heat shield. Perform the process on both sides of the motorcycle (Figure 3).



Figure 3

5. Unscrew the marked muffler bracket bolt and remove the muffler off the motorcycle. Perform the process on both sides of the motorcycle (Figure 4).



Figure 4



6. **For Optional Headers only:** remove the marked plastic fasteners and unscrew cowling bolts on both side of the motorcycle (Figure 5, 6, 7, 8, 9, 10, 11, 12).

! **WARNING:** make sure not to scratch or damage any part of the motorcycle during this process!



Figure 5



Figure 6



Figure 7



Figure 8



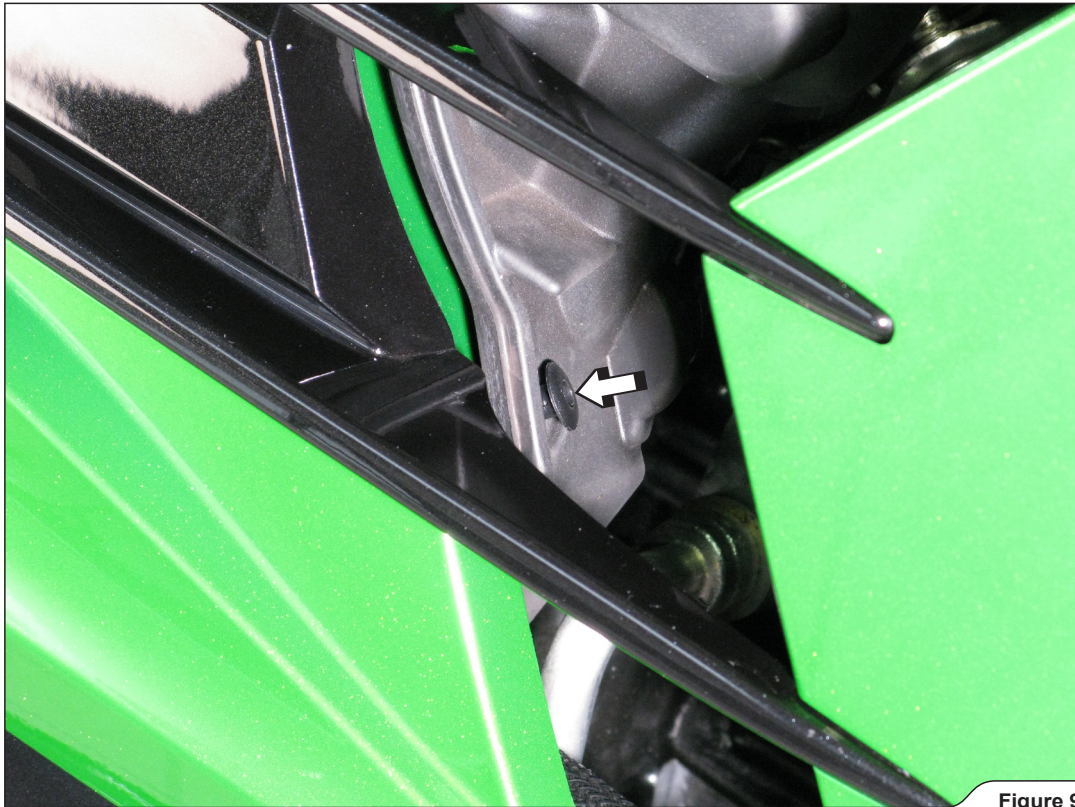

Figure 9



Figure 10





Figure 11

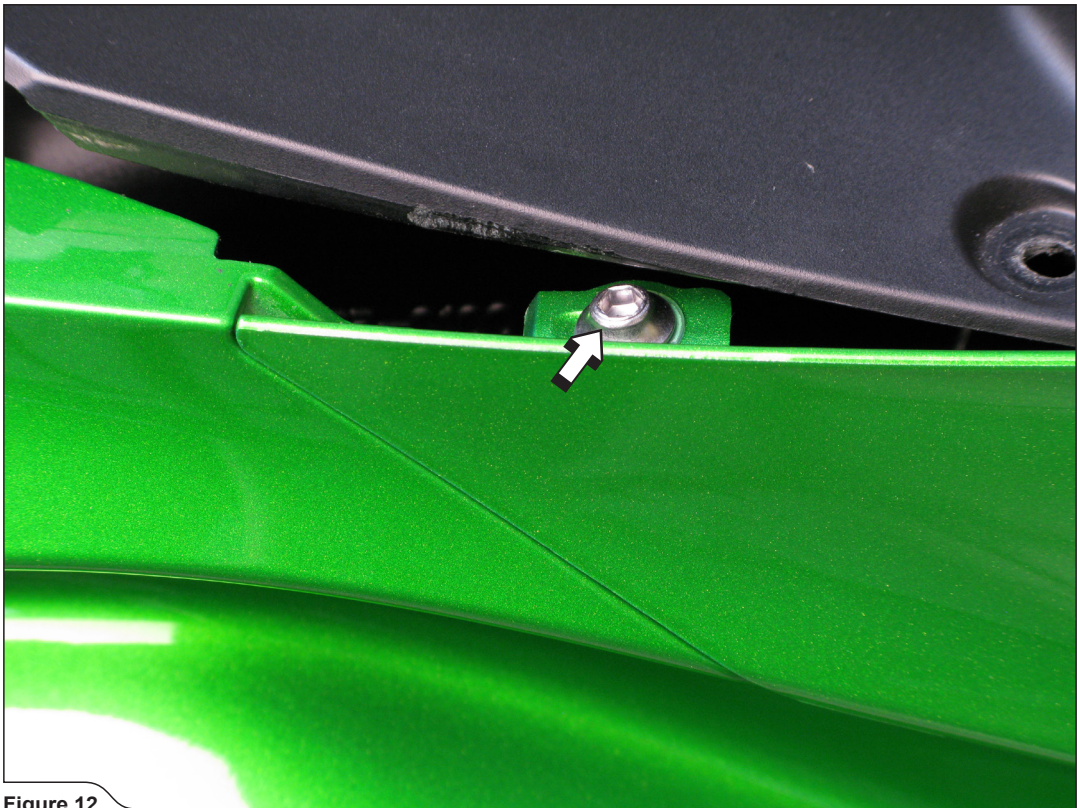

Figure 12



7. **For Optional Headers only:** move the marked rubber protection out of the way as shown, on both side of the motorcycle (**Figure 13**).

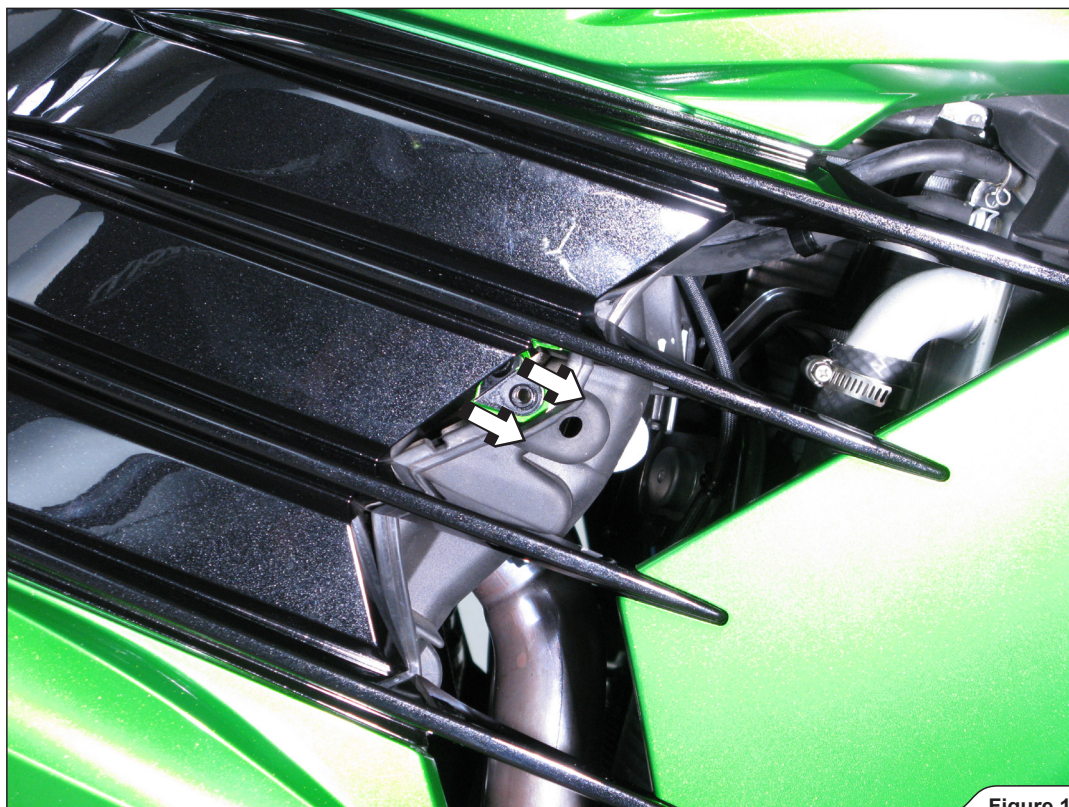

Figure 13

8. **For Optional Headers only:** partially remove the cowling, disconnect the turn indicator's connector and carefully remove the cowling off the motorcycle. Perform the process on both sides of the motorcycle (**Figure 14**).  
**!** **WARNING:** make sure not to scratch or damage any part of the motorcycle during this procedure!

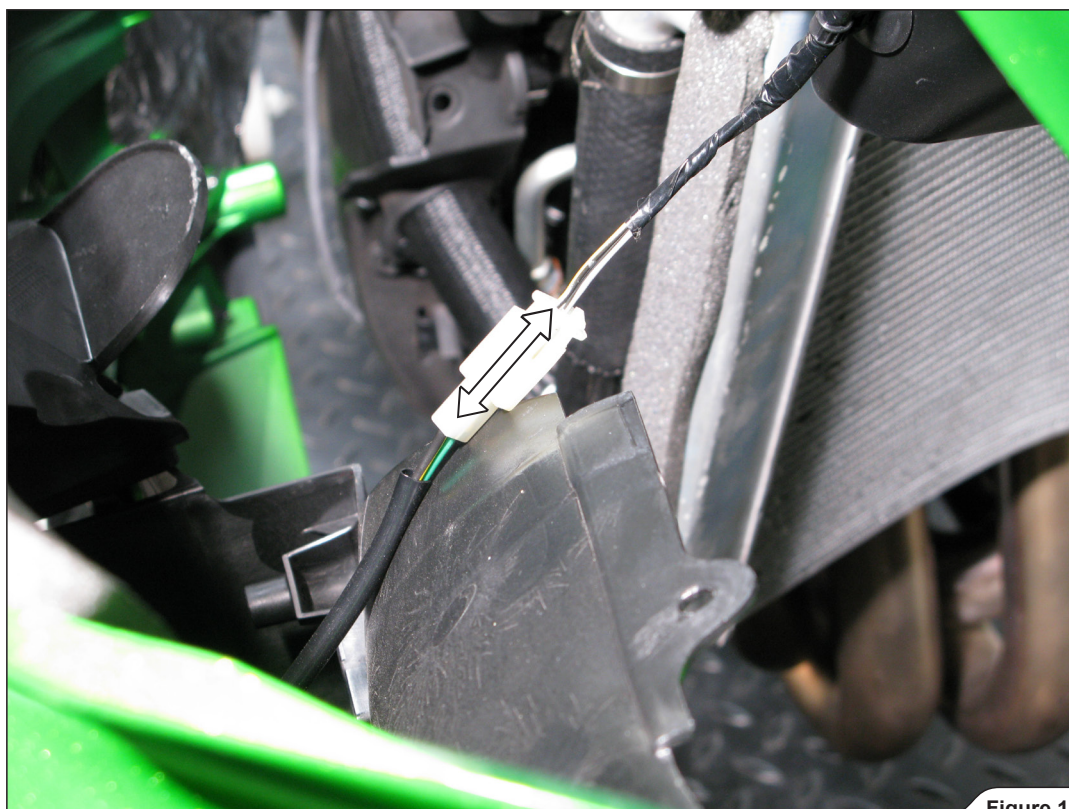

Figure 14



9. **For Optional Headers only:** unscrew the lambda sensor (**Figure 15**).  
! **WARNING:** make sure not to damage the lambda sensor's electrical lead during this procedure!



Figure 15

10. **For Optional Headers only:** unscrew the marked bolts and remove the cooler's bracket off the motorcycle (**Figure 16**).  
! **WARNING:** do not disconnect the cooling system tubes!  
! **WARNING:** make sure not to damage the radiator's cooling fins during this procedure!

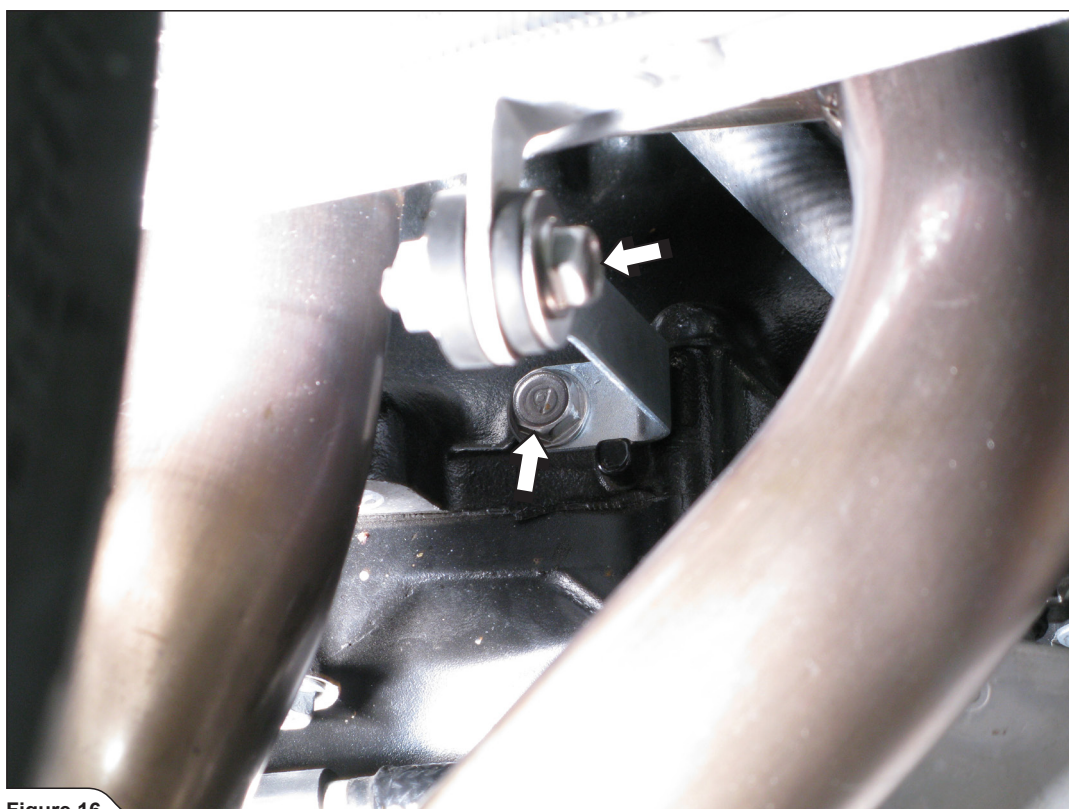

Figure 16

11. **For Optional Headers only:** unscrew all eight flange nuts and remove the stock header pipes off the motorcycle (Figure 17).

! **WARNING:** make sure not to damage the radiator's cooling fins during this procedure!

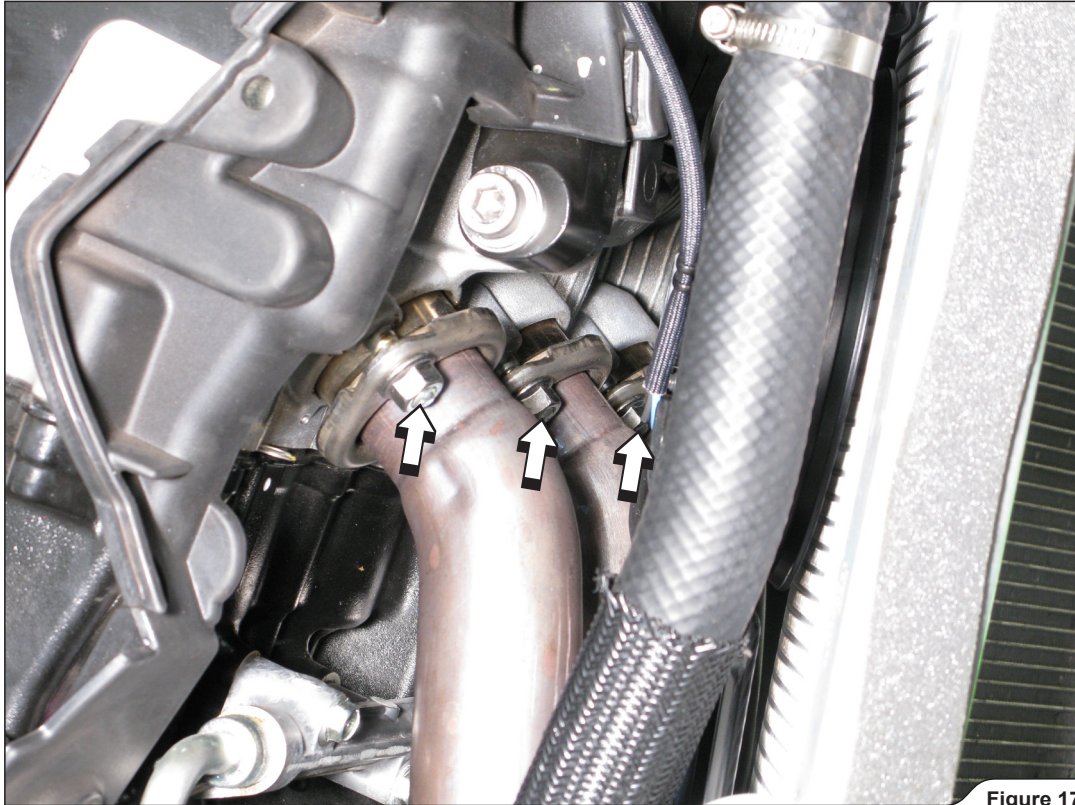

Figure 17

**INSTALLATION OF THE AKRAPOVIČ EXHAUST SYSTEM:**

1. **For Optional Headers only:** set up the sleeves together with the flanges and springs, as shown (Figure 18).



Figure 18



2. **For Optional Headers only:** attach the assembled sleeves, flanges and springs onto the exhaust ports, using stock nuts (Figure 19).

! **WARNING:** hand tighten the nuts only!

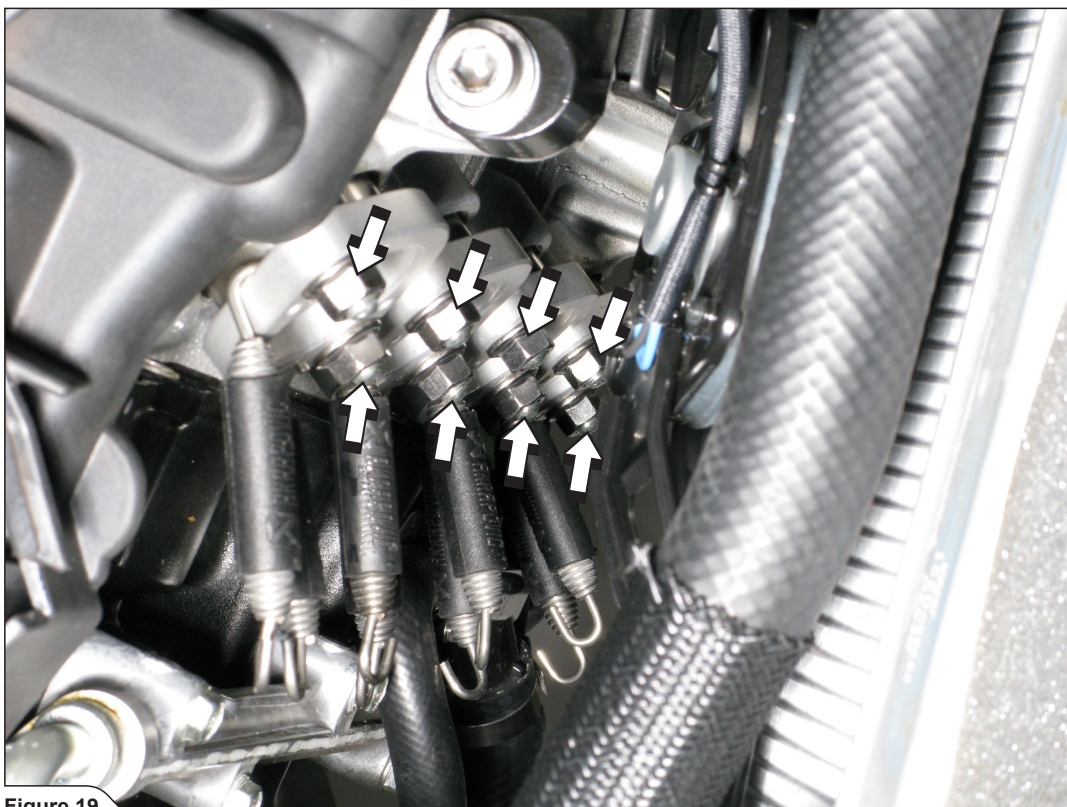

Figure 19

3. **For Optional Headers only:** assemble header tubes and collector as shown and attach all four springs (Figure 20, 21).

! **WARNING:** make sure, that springs pull the collectors all the way onto the headers – use rubber mallet if necessary to tap the connections into place!

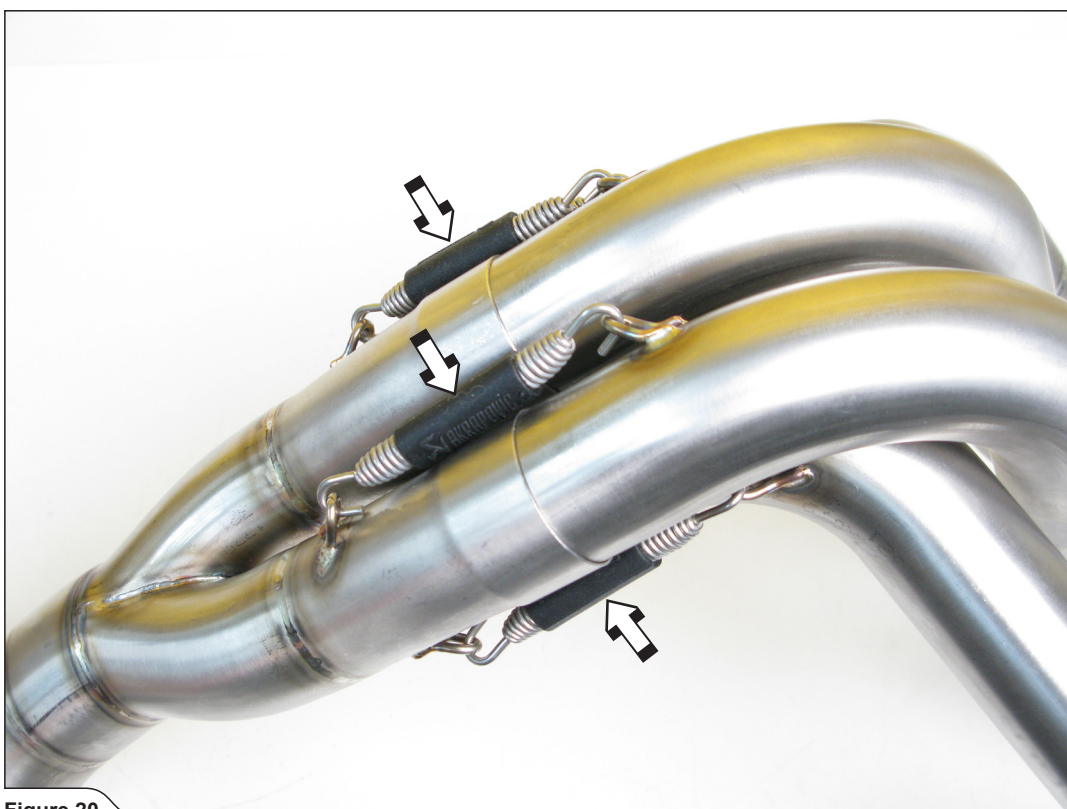

Figure 20





Figure 21

4. **For Optional Headers only:** insert the headers/collector assembly into the sleeves, attach springs and tighten the flanges to specified torque (**Figure 22**).

**!** **WARNING:** before tightening the nuts, make sure, that springs pull the headers all the way into the sleeves – use rubber mallet if necessary to tap the connections into place!

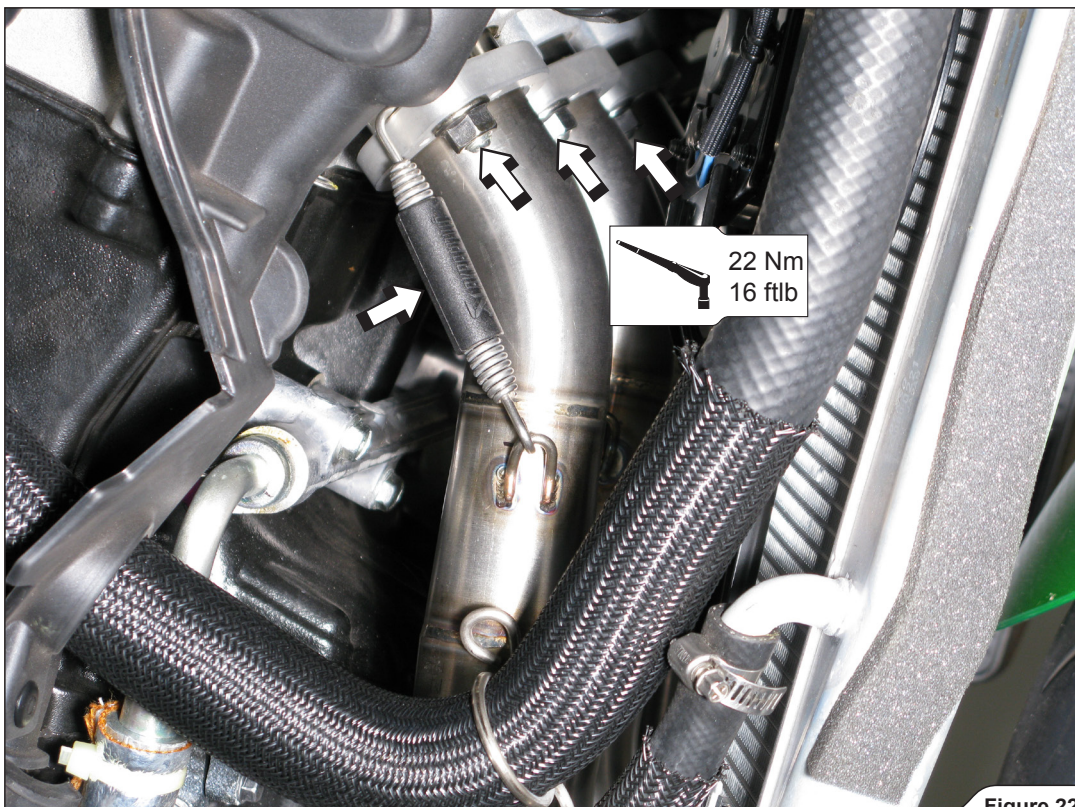

Figure 22



5. **For Optional Headers only:** remove the lambda sensors' connector and reinstall the sensors electrical leads as shown (Figure 23).

! **WARNING:** make sure, not to injure yourself or damage any part of the motorcycle during this process!

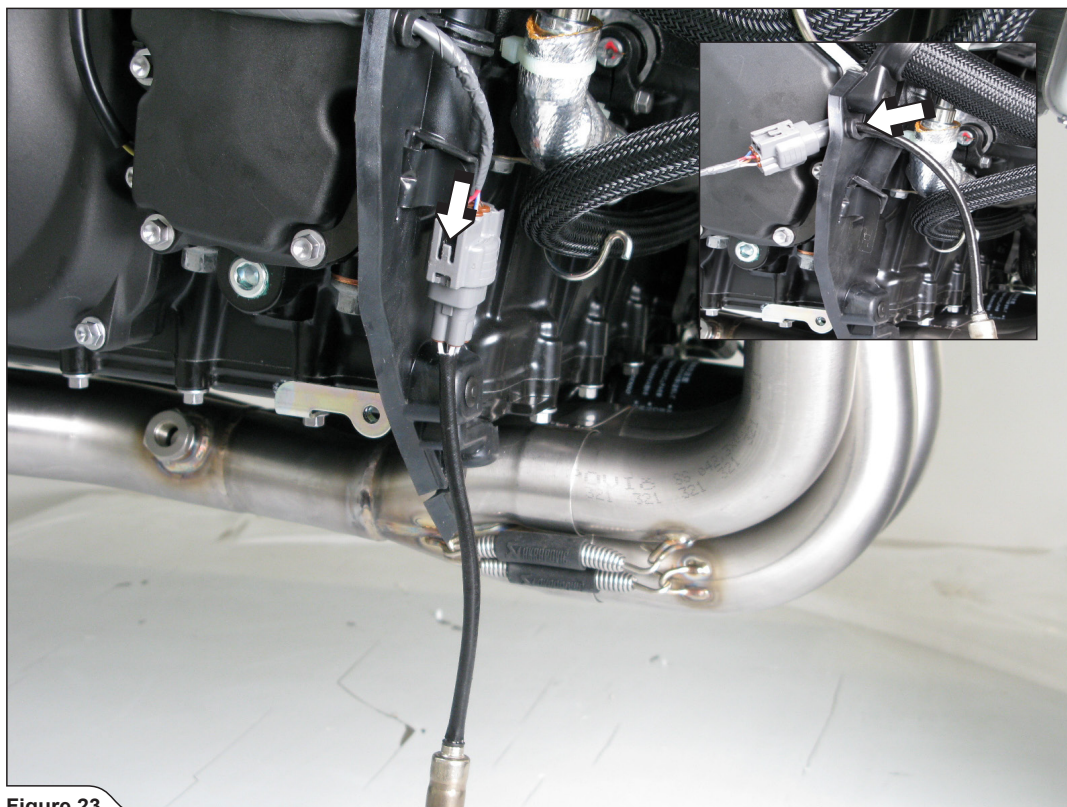

Figure 23

6. **For Optional Headers only:** reposition and secure the lambda sensors' connector as shown - use additional plastic tie wrap (Figure 24).

! **WARNING:** make sure not to damage the lambda sensor's electrical lead during this procedure!

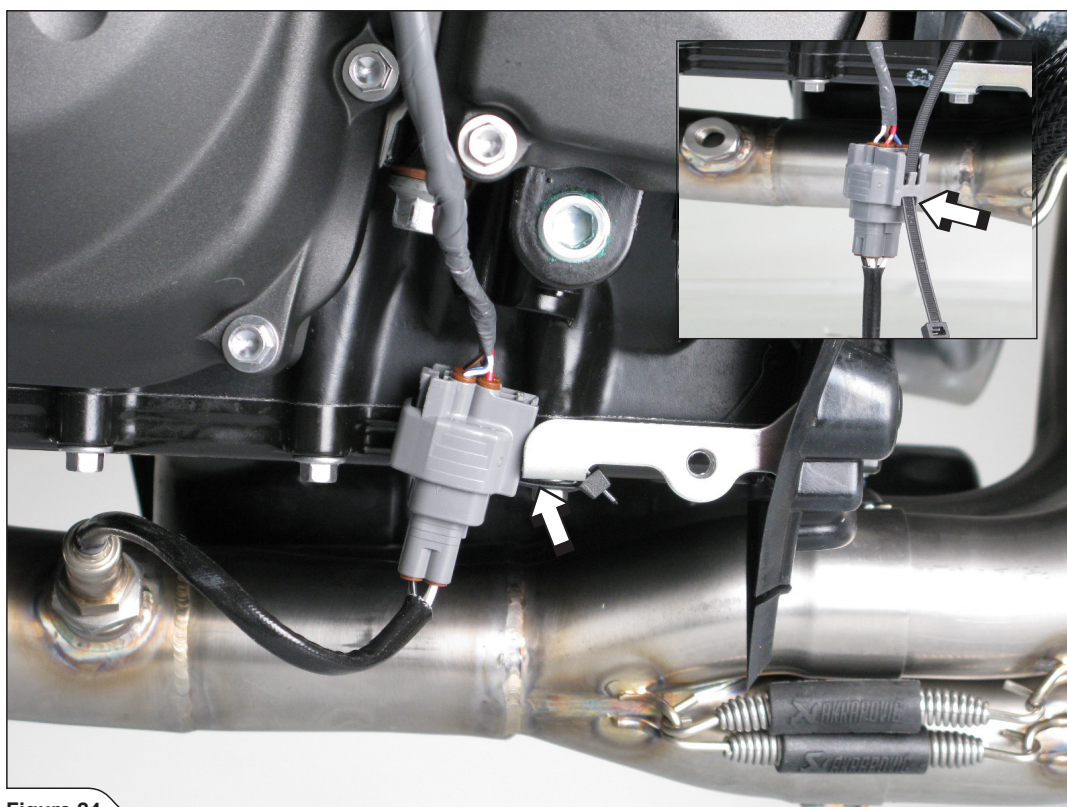

Figure 24



7. **For Optional Headers only:** attach the lambda sensor in to the collector (**Figure 25**).  
! **WARNING:** make sure not to damage the lambda sensor's electrical lead during this procedure!  
! **WARNING:** use anti-seize copper paste only on the lambda sensor threads!

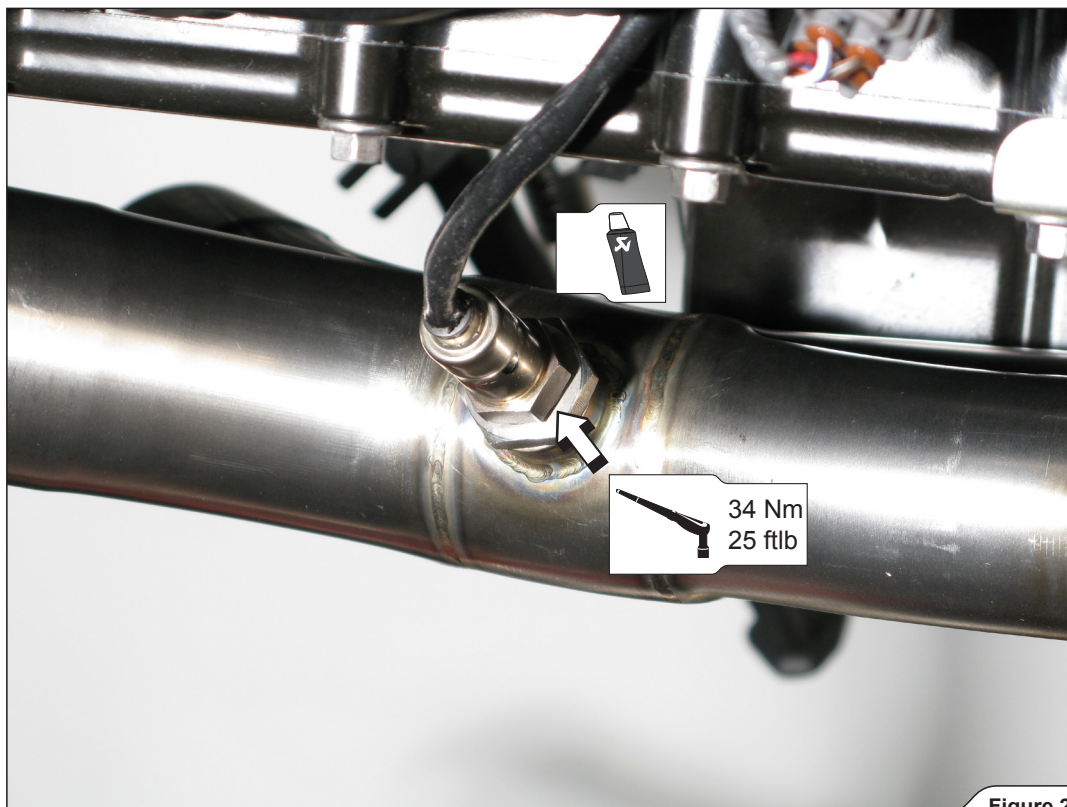

Figure 25

8. **For Optional Headers only:** reattach and tighten the water cooler bracket (**Figure 26**).

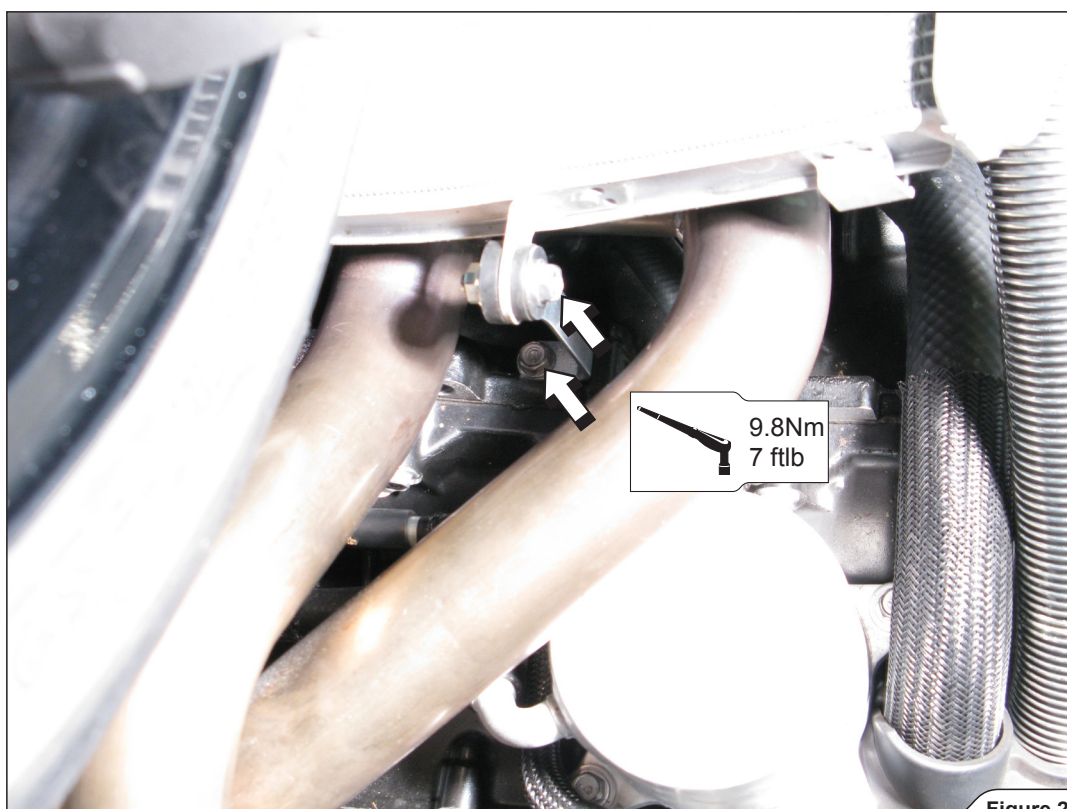

Figure 26



9. Correctly insert Akrapovič catalysts into both link pipe outlets, as shown (Figure 27).  
**!** **WARNING:** make sure that you put the shorter part of the catalyst into the link pipe!



Figure 27

10. Install Akrapovič clamps onto both link pipe inlets as shown (Figure 28).  
**!** **WARNING:** use anti-seize copper paste on bolt threads of the clamps!



Figure 28

11. Slide the Akrapovič link pipes onto the collector outlets and hand tighten the clamps (Figure 29).

! **WARNING: hand tighten the clamps only!**



Figure 29

12. Hand tighten the right link pipe's bracket, using stock bolt, nut and washer (Figure 30).

! **WARNING: hand tighten the link pipe bracket bolt only!**

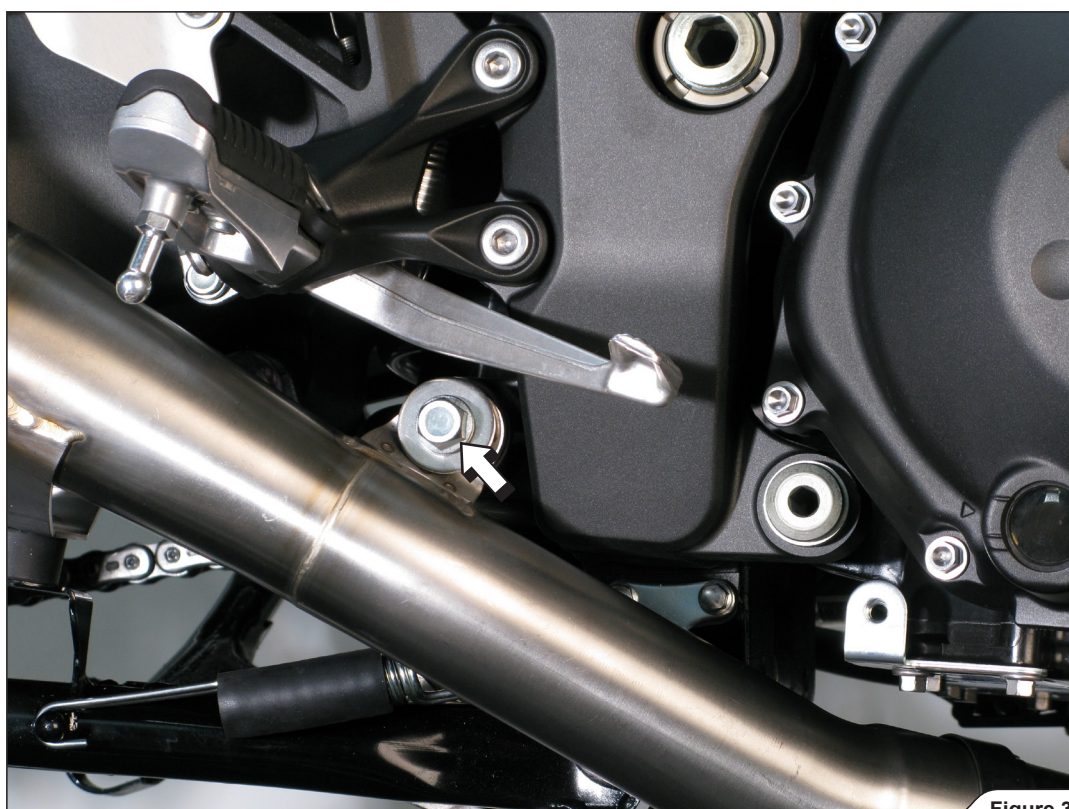

Figure 30



13. Position the muffler correctly and slide it onto the outlet side of Akrapovič link pipe and attach the springs. Align the muffler in respect to the motorcycle and tighten the muffler bracket using Akrapovič bolt, aluminium collar and stock washer and nut. Perform the process on both sides of the motorcycle (Figure 31, 32, 33).

! **WARNING:** make sure, not to damage or scratch the mufflers during this procedure!



Figure 31

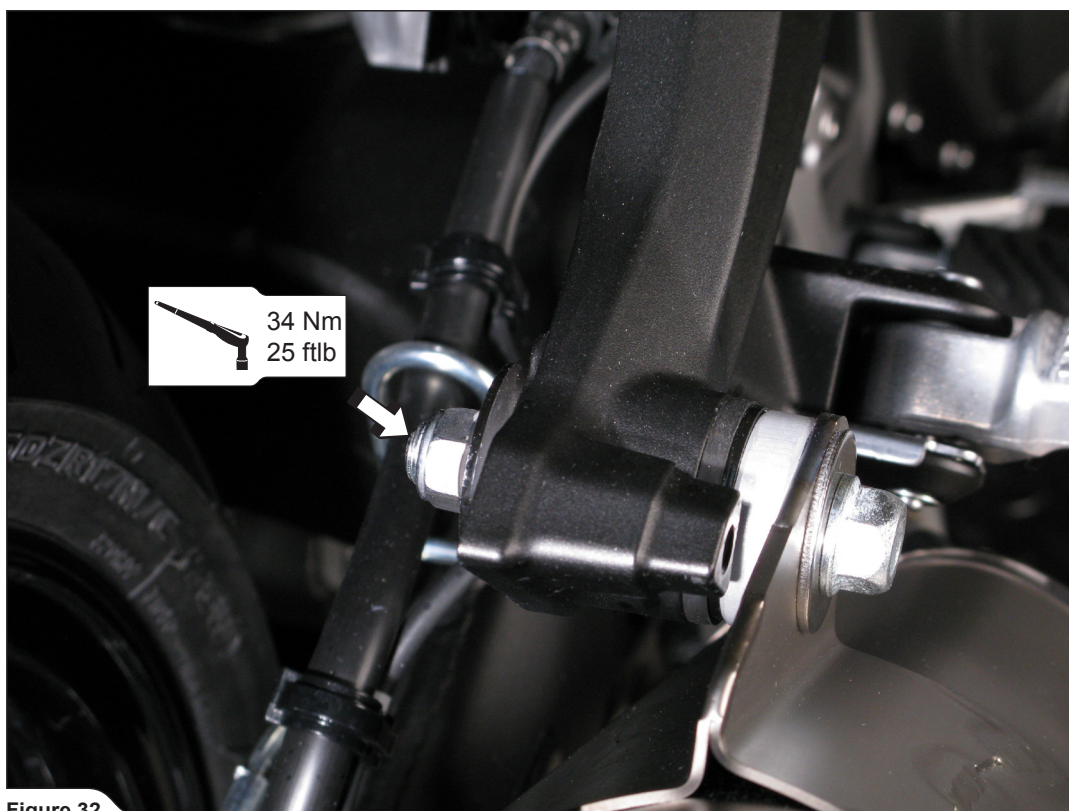

Figure 32



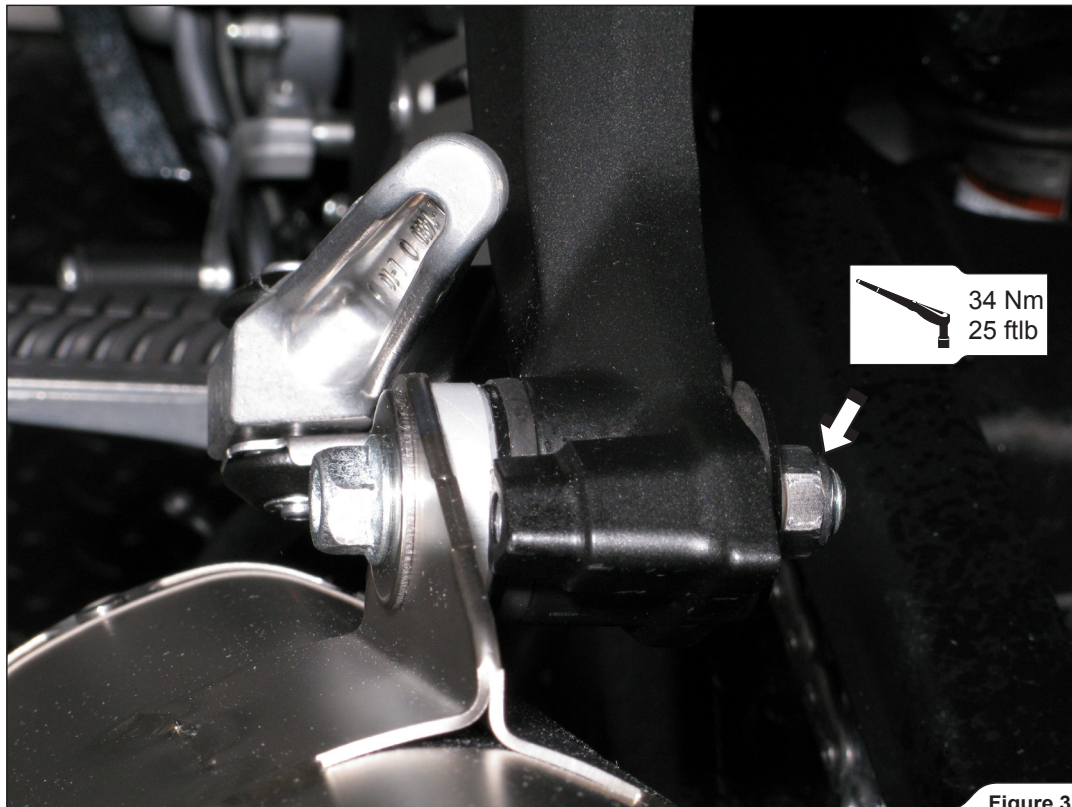

Figure 33

14. Fully tighten the link pipe bracket on the right side of the motorcycle (Figure 34).

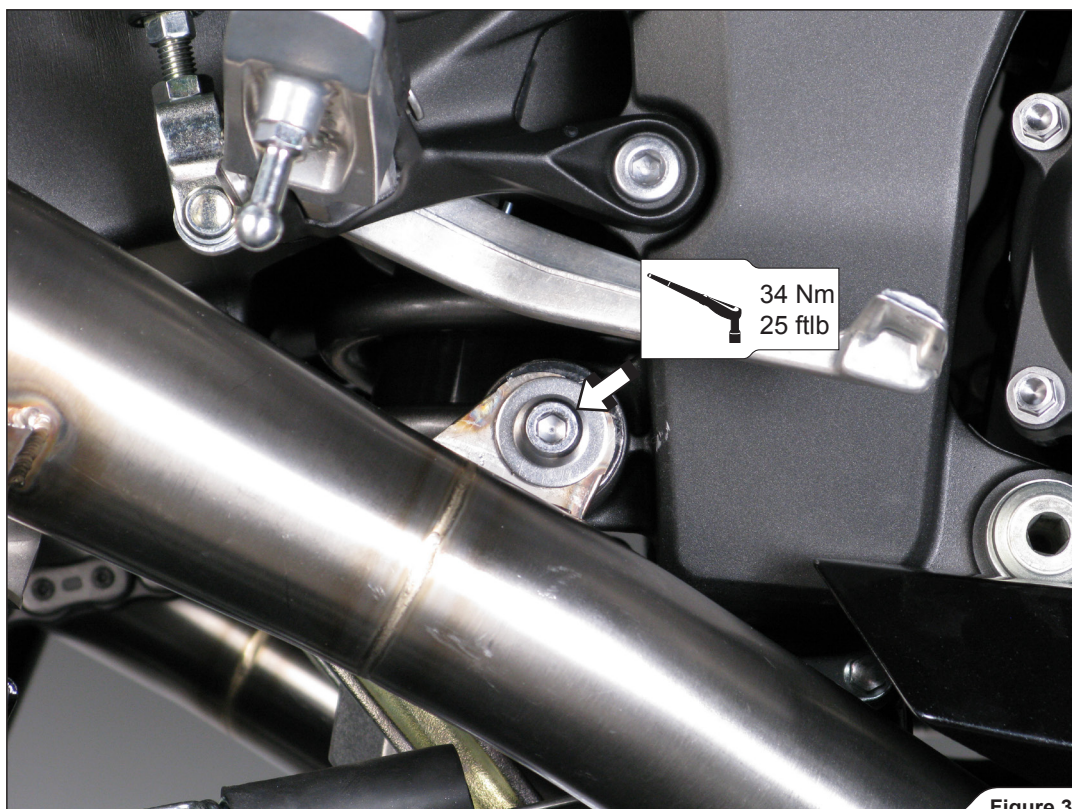
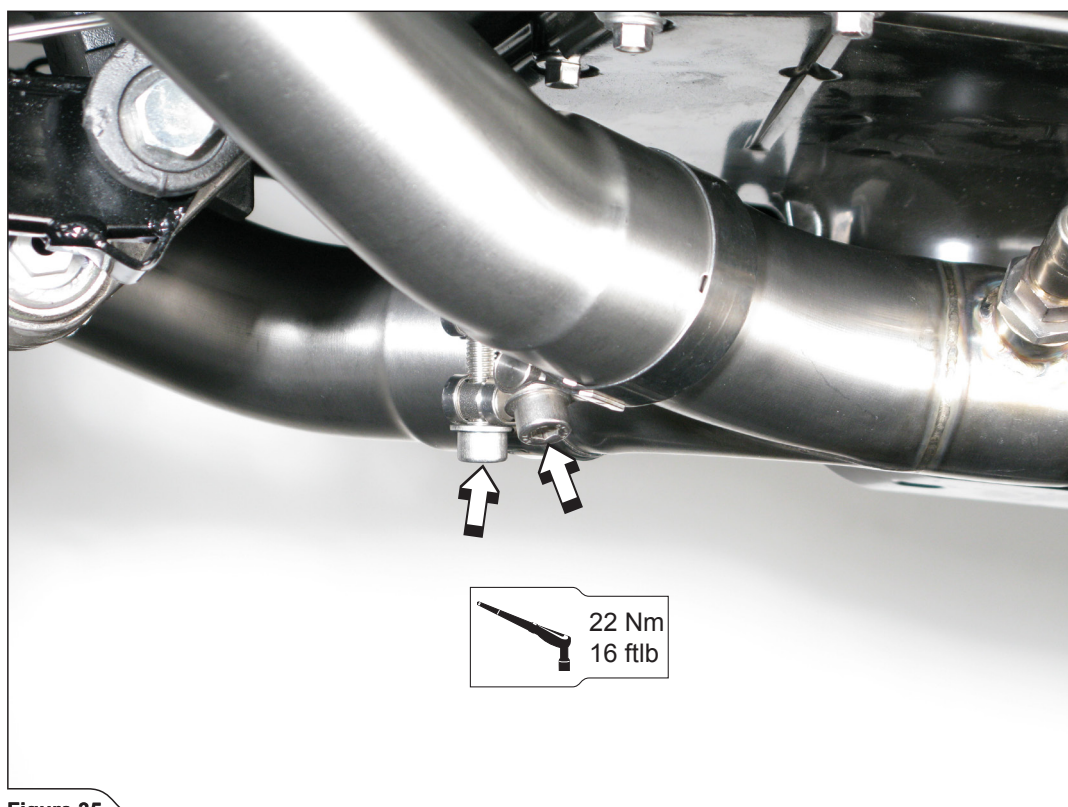

Figure 34



15. Tighten both metal clamps at the Akrapovič link pipes/collector joint to a specified torque (**Figure 35**).



**Figure 35**

16. Assemble the heat shield bolts and heat resistant washers onto the carbon fiber heat shields, as shown (**Figure 36, 37**).

**✂ INSTALLATION TIP:** screw the heat resistant washers onto the bolts; do not try to push them on!



**Figure 36**



Figure 37

17. Attach the heat shield onto the link pipe and tighten it to a specified torque. Perform the process on both sides of the motorcycle (Figure 38).

! **WARNING:** make sure the heat shield is not touching the link pipe or any other parts of the motorcycle!

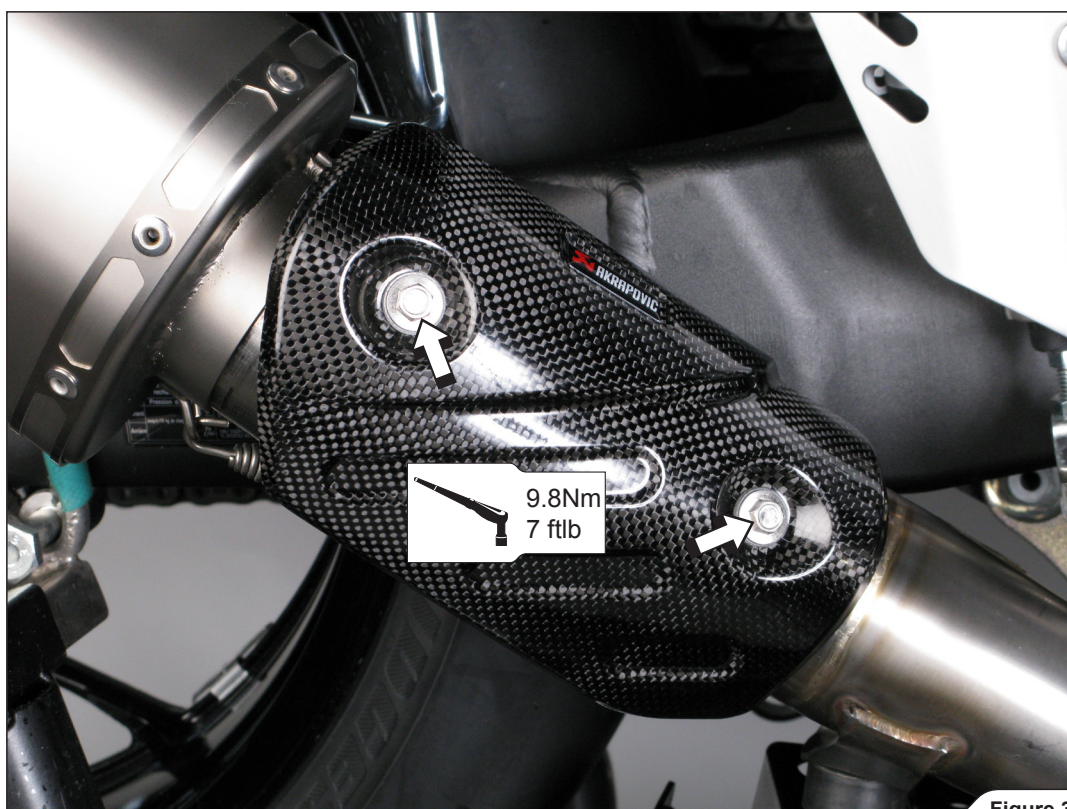

Figure 38



18. Reconnect the turn signal electrical connectors and replace all cowlings in the reverse order from the order in which they were removed (Figure 39).

! **WARNING:** make sure, that you reconnect all electrical leads which were disconnected during installation!

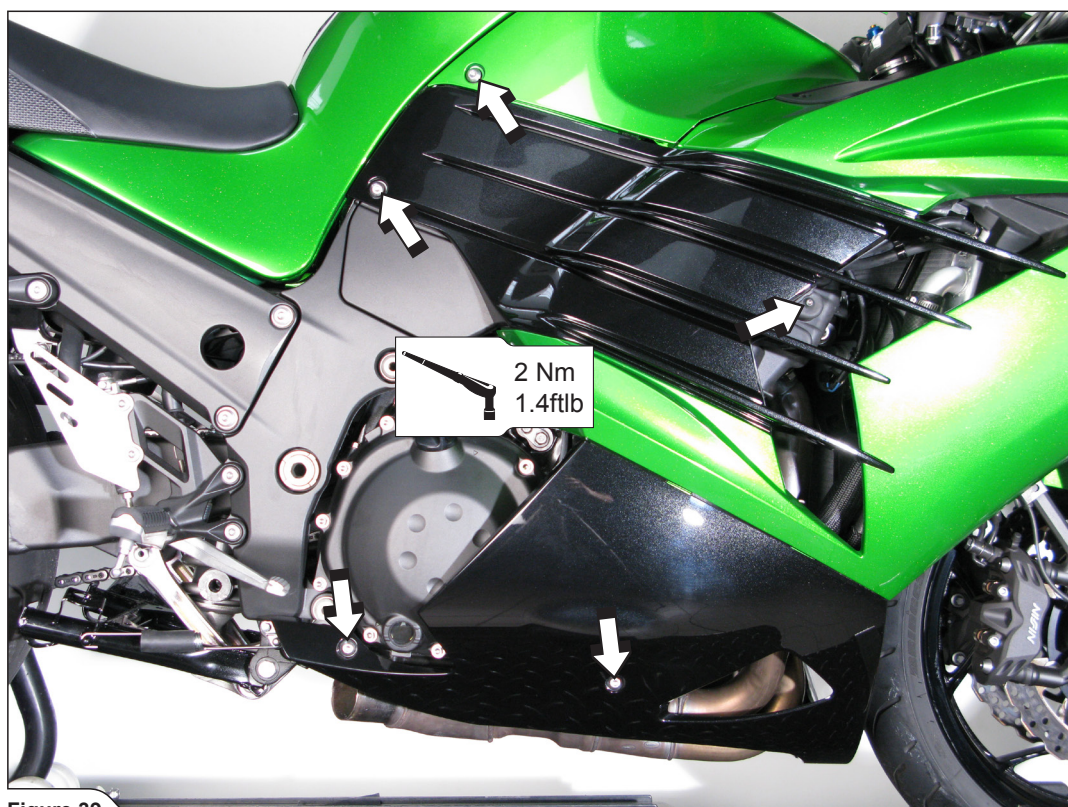

Figure 39

#### Final installation:

Clean grease spots:

- Muffler – carbon-fiber outlet cap: use a soft dry cloth.
- Muffler – titanium outer sleeve: use a soft cloth sprayed with a multi-purpose spray lubricant (WD-40 or equivalent).
- Stainless steel link pipes, collector and header pipes : use a soft cloth sprayed with a contact cleaner, then wipe with a soft dry cloth.

Cleaning will prevent spots from burning onto the surface. Do not use aggressive chemical cleaners, because they can damage the sticker.

! **WARNING:** make sure all the bolts are sufficiently tightened. In case the exhaust system touches the cowl or other parts repeat the adjustment of the exhaust system or contact your authorized dealer.

! **WARNING:** check vehicle manufacturer manual for tightening torques (for dismantled stock parts)!

! **IT IS NORMAL IF WHITE SMOKE COMES OUT OF THE MUFFLER ON FIRST OPERATION.**

! **DO NOT STAND BEHIND THE MUFFLER ON FIRST OPERATION.**

! **DO NOT USE AUTOMOTIVE WHEEL CLEANERS OR ANY CLEANING PRODUCTS WHICH CONTAIN ACIDIC ADDITIVES TO CLEAN AKRAPOVIČ EXHAUST SYSTEMS.**

#### **MAINTENANCE OF THE AKRAPOVIČ EXHAUST SYSTEM:**

- Clean the titanium exhaust components with a multi-purpose spray lubricant (WD-40 or equivalent), carbon fiber exhaust components with soft and dry cloth and stainless steel components with soft cloth sprayed with contact cleaner, then wipe with soft and dry cloth. A change in the color of the exhaust system is normal due to the high temperatures.
- Periodically make sure all the bolts and springs are sufficiently tight.

**WARNING:**

Please note that certain aftermarket exhaust systems may not comply with applicable California laws and regulations, and may therefore be prohibited for use on California highways or roads, or on roads or vehicles otherwise subject to emissions control requirements.

Akrapovič exhaust systems for automobiles and motorcycles mounted downstream of the catalytic converter (also known as "cat-back systems") are considered "replacement parts" in California by the California Air Resources Board (CARB), and do not require an exemption or executive order from CARB to be sold in California. However, California prohibits the use of any aftermarket exhaust system that modifies, removes or replaces original equipment catalyysts, unless CARB has issued an Executive Order as to such part or system.

Further, Akrapovič parts or exhaust systems used or intended for use on "racing vehicles" (i.e. a competition vehicle used exclusively for competition on closed-course circuits) do not require an exemption or Executive Order from CARB to be sold in California. However, such parts are prohibited from use on California public highways or roads, even if occasionally used "off-road."